

OWNER'S MANUAL

BERCHTOLD. **podoQ 40** MADE IN GERMANY

Serial No.: _____ Date of Purchase: _____

PREVENTATIVE MAINTENANCE:

Just like your car - a Podiatry Drill will operate best when serviced regularly.

In consultation with the Manufacturer, Briggate Medical Company recommend that this appliance be sent to us for inspection every:

**24 MONTHS
SERVICE FREQUENCY**

Preventative Maintenance scope:

- dis-assemble and clean
- vacuum motor clean and test
- circuit board inspection/clean
- handpiece clutch inspection/re-build
- handpiece motor testing
- handpiece bearing replacement
- electrical test and tagging



briggatemedicalcompany

IMPORTANT:

Please read these instructions, especially the sections titled "Dismantling the Handpiece" and "Burr Clutch Service"

You may also wish to refer to the the instructional video located in the Product Videos section of our website - www.briggatemedical.com

WARRANTY DETAILS:

Term: 36 Months (from date of purchase)

Conditions:

- This warranty is set out by the Manufacturer against faulty parts and/or workmanship.
 - Briggate Medical Company is the sole authorised warranty repair agent in Australia and New Zealand.
 - All warranty and service works are performed at Briggate Medical Company's service facility; 23-25 Lakewood Blvd, Braeside, Victoria, 3195. No freight charges will be accepted for the return of this appliance to Briggate Medical Company - regardless of warranty claim outcome.
 - This warranty does not cover wear and tear on the bearings and clutch mechanism within the handpiece.
 - This warranty will be VOID if there is evidence of dust bags NOT being used during operation.
-

INDEX

2	Technical Data
2	Safety Instructions
3	Main Features & Controls
3	Touch Pad Button Functions
3	Touch Display Functions
4	Operational Instructions
4	Programming Memory Slots
4	Hints & Troubleshooting
5	Changing the Dustbag
6	Touch Screen Display Fault Analysis
6	Warranty Details
7-10	Dismantling the Handpiece
11-13	Burr Clutch Service
14	PodoQ Handpiece Dismantling Video
15	Handpiece Holster Positioning

Technical Data

Measurements:	290mmW x 80mmH x 250mmD
Equipment:	Main Control Box, Micro-Motor Handpiece, Vacuum/Power Hose, Dustbags, Mains Power Lead, Operating Instructions
Total Weight:	2.4 kg
Handpiece Weight:	140 g
Noise Level:	62dB
Power:	240V
Warranty:	36 Months (Return to Base)
ARTG#:	161350

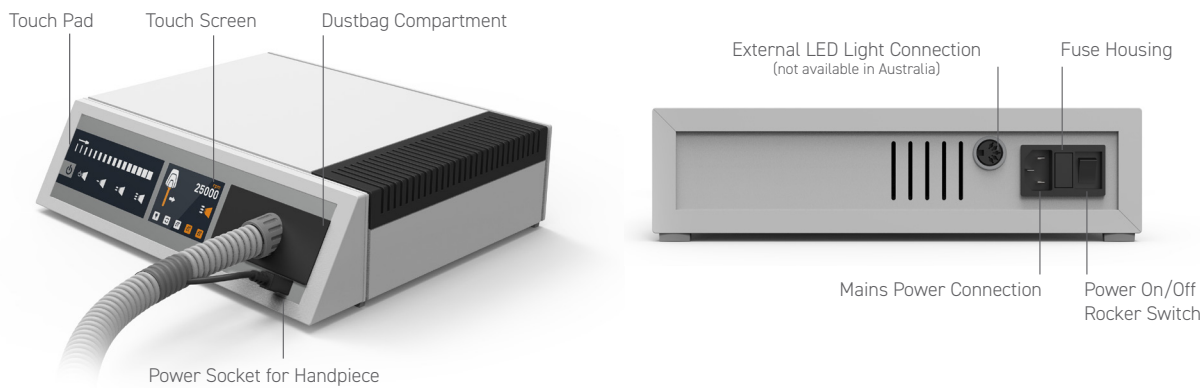

Safety Instructions Please ensure the following are strictly adhered to:

- DO NOT use bent or damaged mandrels and burrs (tools).
- Only use quality tools which have a shaft diameter of 2.35mm (some inferior tools may have undersized shafts which may slip and damage the Handpiece).
- To reduce any chance of overheating ensure clearance of at least 25mm around all sides of the Main Control Box. Ensure the ventilation slots in the Main Control Box are clear of any blockage.
- Ensure no liquids enter the Main Control Box or Handpiece.
- DO NOT clean the the Main Control Box with an alcohol based cleaner. Only use an alcohol-free surface wipe (eg: Clinell).
- The Main Control Box can only be opened by authorised service technicians. Unauthorised opening of Main Control Box will negate the Manufacturers Warranty.
- Do not operate the PodoQ Drill in extremely hot or very damp conditions.
- Prior to dismantling the handpiece for cleaning, it is imperative that you read the section titled "Dismantling the Handpiece" on Pg 7. Failure to do so may result in damage that will NOT be covered under warranty.

Main Features & Controls

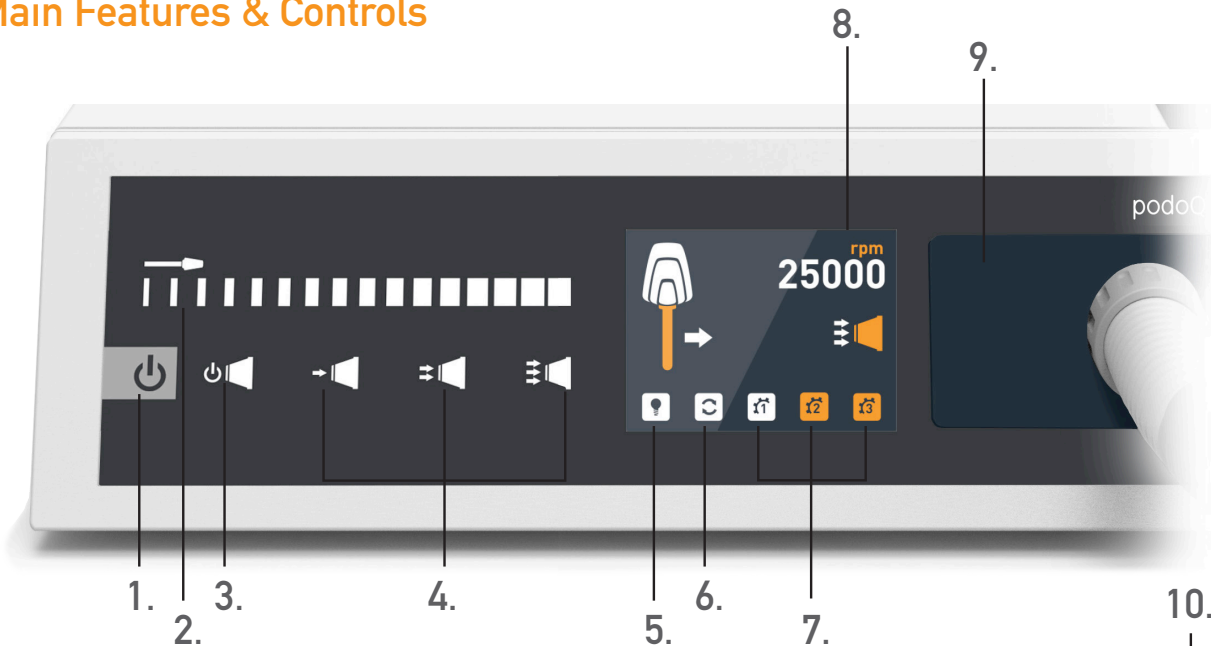

- 1. Start/Stop Button
- 2. Burr Speed Control Slider
- 3. Suction Stop/Stand-by Button
- 4. Vacuum Level Switches
- 5. External LED Light Switch (not available in Australia)
- 6. Burr Rotation Switch
- 7. Memory Buttons
- 8. Burr Speed Indicator
- 9. Dustbag Compartment (behind vacuum hose face plate)
- 10. Handpiece On/Off Switch

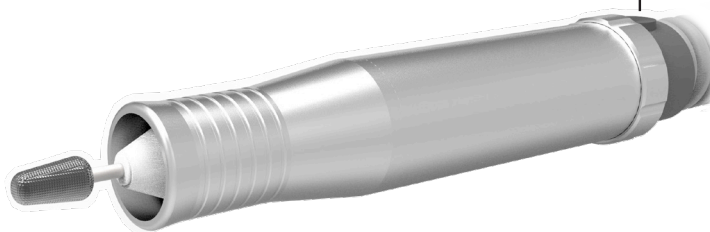

Touch Pad Button Functions



Start/Stop Button
Starts/Stops selected burr speed and direction, and vacuum suction.



Suction Stop/Stand-by Button
Stops suction and activates Stand-by Mode. Hold button for 4 seconds to activate Stand-by Mode.

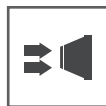
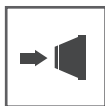

Suction Level Buttons

Selects Low, Medium or High vacuum suction.



Burr Speed Control Slider

Slide finger across to adjust Burr Speed (5,000rpm-25,00rpm).

Touch Display Functions



Burr Direction & Size Indicator
Displays current Burr Direction and suitable burr size for selected Burr Speed.

5,000-10,000 rpm	Large Burr
10,000-20,000 rpm	Medium Burr
20,000-25,000 rpm	Small Burr



Burr Speed Indicator
Displays currently selected Burr Speed.



Suction Strength Indicator
Displays currently selected Vacuum Strength (Low, Medium or High).



External LED Light Switch
(not available in Australia)



Burr Direction Button
Switches Burr Direction clockwise/anti-clockwise.



Memory Buttons
Press to select saved preferred settings. Refer to Pg 4 for instructions on how to programme memory slots.

Operational Instructions

Where numbers are listed (eg: No.1) refer to Pg 3 for Button clarification.

1. Connect the orange power lead into the back of the Main Control Unit.
2. Plug the main power lead into a power point and turn the power point on.
3. Ensure a Dustbag is fitted to the unit. Refer to Pg 5 for instructions on fitting a Dustbag.
4. Insert your selected Burr or Mandrel into the Handpiece, pushing it firmly into place. (The Burr Clutch will lock/unlock automatically when the Handpiece is turned on/off).
5. Turn the Drill on by pressing the Power On/Off Rocker Switch at the rear of the unit.
6. Select the direction you wish to have the Burr/Mandrel travel (clockwise or anti-clockwise) by pressing the Burr Rotation Button (No.6) located on the bottom of the touch screen.
7. Select the speed you wish the Drill to operate at by sliding the Burr Speed Control Slider (No.2). Slide from left to right to increase speed, slide from right to left to decrease speed. The range is from 5,000rpm to 25,000rpm.
8. Select the Vacuum Strength level by pressing one of the three Suction Level Buttons (No.4).
9. Activate the operation of the unit by pressing the Handpiece On/Off Switch (No.10). Pressing it a second time will de-activate the Handpiece.

Programming Memory Slots

The Berchtold PodoQ features the option to save preferred working settings (i.e: Burr Direction, Vacuum Strength & Burr Speed) and to access them at the touch of a button. Follow the steps below to programme the three Memory Slots available:

1. Using the Burr Speed, Burr Direction and Suction Level Buttons, adjust the drill to function at your desired outcome.
2. Press and hold the Start/Stop Button (No.1).
3. Whilst holding the Start/Stop Button press the desired Memory Button (No.7) on the Touch Screen.
4. Your preferred setting will now be saved to the Memory Button you selected.

Hints & Troubleshooting

This is an electrically operated piece of equipment. Never allow liquid to come into contact with the Main Control Unit, or the Handpiece.

Never put any liquid or lubricant in the Handpiece.

DO NOT allow the Vacuum System to draw liquid into the Handpiece.

If the Dustbag Full Warning appears on the Touch Screen Display and the Dustbag is not full

- This warning comes on when the vacuum airflow starts to diminish as a result of the Dustbag being full. However, there may be a blockage caused by a build-up of nail dust and lint within the Handpiece air cavity. A full disassembly of the Handpiece should identify any blockages. (Please refer to your [Dismantling the Handpiece Chart](#) to help you disassemble and re-assemble the Handpiece).

When using the Drill, you find the Burr or Mandrel stops spinning when pressure is applied to the foot being sanded

- It is possible there is a build up of fine debris within the Burr Clutch. Refer to your [Burr Clutch Service Chart](#), remove and clean the Burr Clutch taking particular care to clean the inside of the Burr Clutch Assembly (Remember: DO NOT use liquids or lubricants when cleaning these components).

If any other faults or issues arise that are not detailed in this document please contact our Service Department on 1800 33 4142 .

Changing the Dustbag

When the Dustbag Symbol appears on the Touch Screen, the Dustbag should be replaced.

To do this:

1. Switch the unit OFF by pressing the Power On/Off Rocker Switch at the rear of the Main Control Unit.



2. Pull the Handpiece Power Socket out from the Main Control Unit. **DO NOT REMOVE VACUUM HOSE FACE PLATE UNTIL THE HANDPIECE POWER SOCKET HAS BEEN REMOVED.**

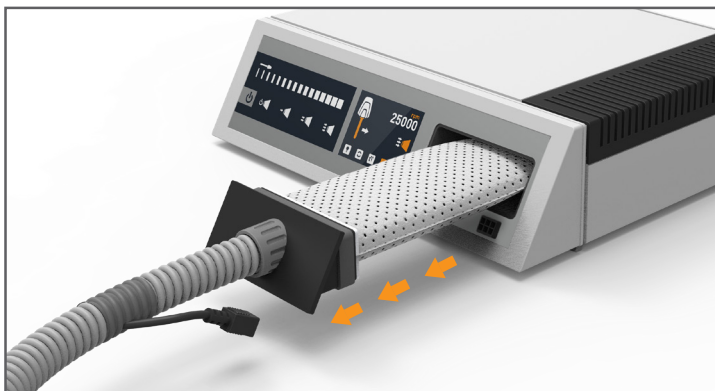

3. Gently pull the Vacuum Hose Face Plate (No.9) out of the Dustbag Compartment (the Dustbag should come out with it).

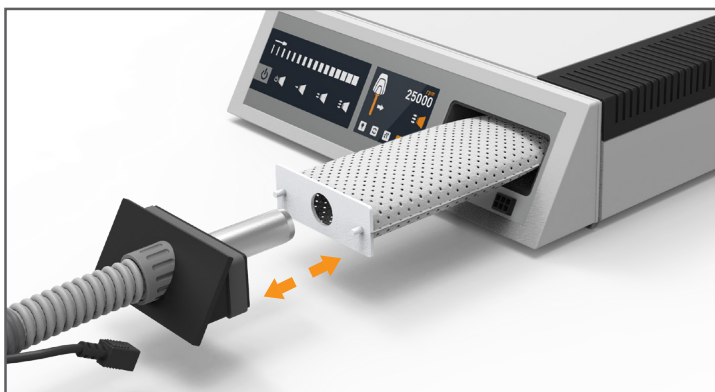



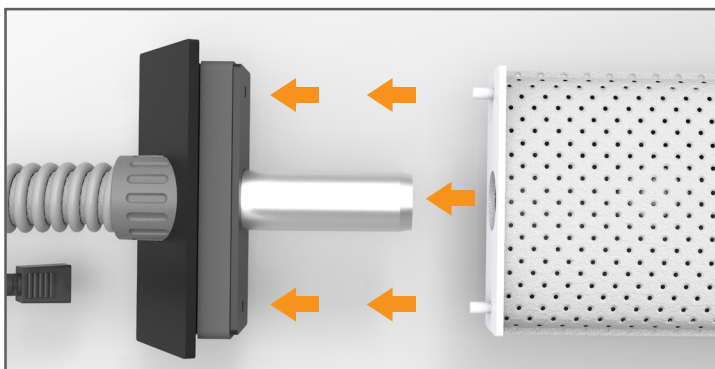

4. Remove the Dustbag from the alloy Vacuum Hose Exit Pipe by pulling it free. Dispose of the full Dustbag.



5. Slide the new Dustbag onto the alloy Vacuum Hose Exit Pipe. Ensure the two male pins of the Dustbag connect into the female ports at the rear of the Vacuum Hose Face Plate. This will reduce the chances of the Dustbag coming loose while the drill is in operation.

6. Finally, insert the now connected Dustbag into the Dustbag Compartment and firmly press the Vacuum Hose Face Plate back into the Main Control Unit.

Touch Display Fault Analysis

Error Symbol	Cause	Solution
 Dustbag	<ul style="list-style-type: none"> - Dustbag full - Possible blockage in Handpiece 	<ul style="list-style-type: none"> - Remove and replace dustbag - Dismantle and clean Handpiece as specified in sections titled "Dismantling the Handpiece" on Pg 9 and "Burr Clutch Service" on Pg 11
 Handpiece	<ul style="list-style-type: none"> - Handpiece Power Plug not connected properly - Possible blockage in Handpiece - Possible Handpiece motor failure <p>REFER BELOW</p>	<ul style="list-style-type: none"> - Remove and insert Handpiece Power Plug - Dismantle and clean Handpiece as specified in sections titled "Dismantling the Handpiece" on Pg 9 and "Burr Clutch Service" on Pg 11 - Contact Briggate Medical if problem persists
 Vacuum Motor	<ul style="list-style-type: none"> - Problem with Suction 	<ul style="list-style-type: none"> - Turn off unit via Main Power Switch at rear of unit - Turn on unit via Main Power Switch at rear of unit - Contact Briggate Medical if problem persists
 Hardware	<ul style="list-style-type: none"> - Hardware error 	<ul style="list-style-type: none"> - Turn off unit via Main Power Switch at rear of unit - Turn on unit via Main Power Switch at rear of unit - Contact Briggate Medical if problem persists



An error stating ID# 108 Data: 00035 is usually in relation to the Handpiece Power Plug not being connected properly. Remove and re-insert the plug ensuring it is pushed in as far as it can go.

If any other faults or issues arise that are not detailed in this document please contact our Service Department on 1800 33 4142 .

Warranty Details

Briggate Medical Company Warrants this Berchtold PodoQ Podiatry Drill to be free from Manufacturing defects for a period of 36 months from the date of purchase which is considered to be the date of shipment from our premises.

Warranty does not cover any issues with "wear and tear" items such as worn or noisy bearings, a blocked Handpiece or any other general maintenance issues.

It is imperative that you complete the Registration details sheet provided with your new drill and return the document to us promptly.

No Warranty will be extended to unregistered equipment.

Packing, Handling and Delivery Charges are applicable on ALL Equipment and Instrument Service and Repairs, irrespective of the final Invoice Value of such Service or Repair.

Damage resulting in failure to comply with instructions given in this manual or as the result of mis-use will NOT be covered under Warranty.

Dismantling the Handpiece

Summary of Parts

A unique feature of the Berchtold handpiece is its ability to be completely dismantled, cleaned, and re-built. To ensure optimal performance of your Berchtold handpieces we suggest that this be performed every 2-3 weeks.

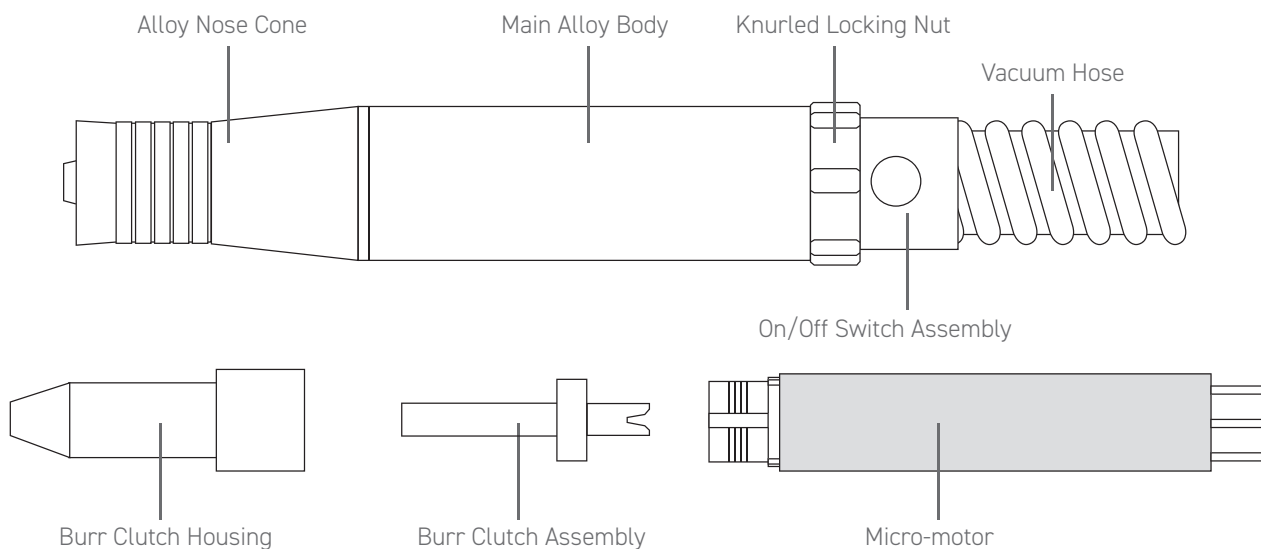

Step 1

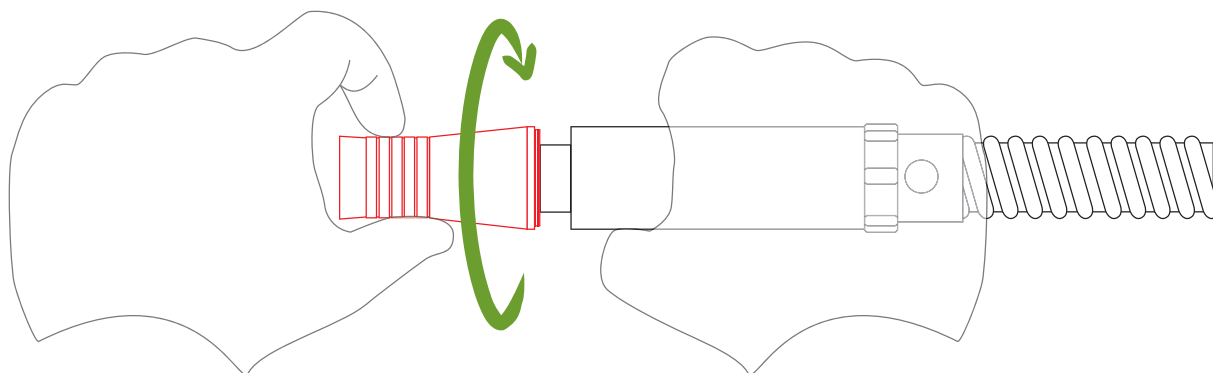

Hold the Main Alloy Body of the Handpiece in one hand, then unscrew and remove the Alloy Nose Cone.

Step 2

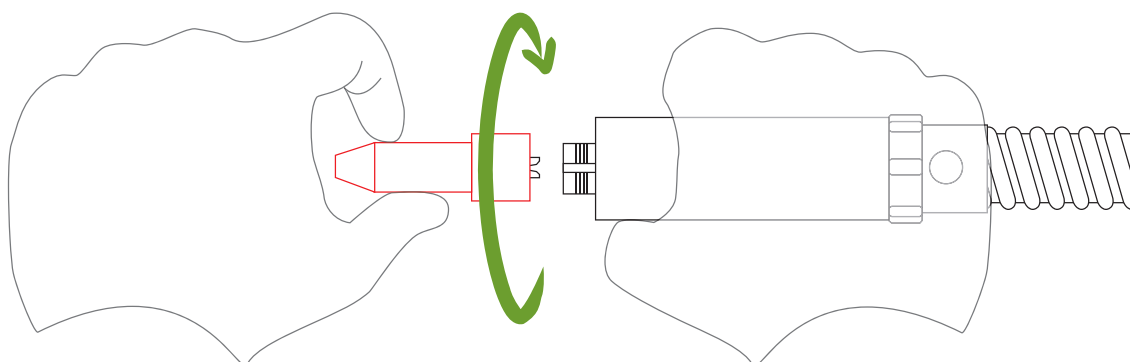

Then unscrew and remove the Burr Clutch Housing.

Step 4

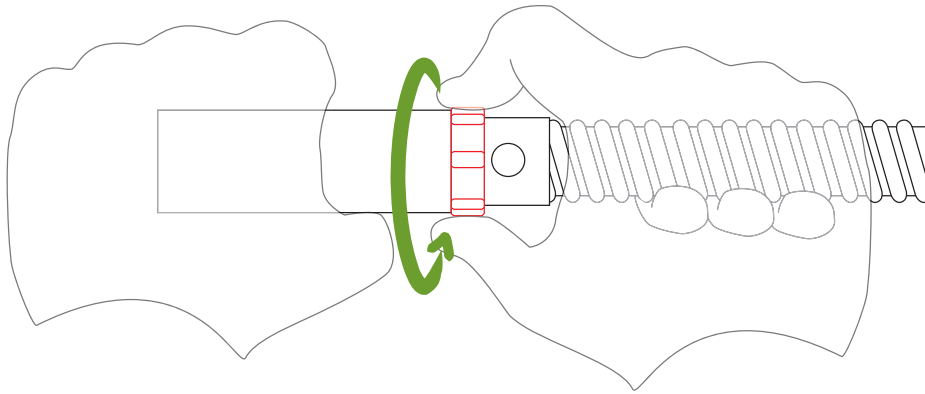

Once the nose cone and Burr Clutch Housing have been removed, hold the Main Alloy Body (which has the Micro-motor in it) in one hand and the On/Off Switch Assembly and Vacuum Hose in the other hand.

Now gently unscrew ONLY the Knurled Locking Nut with your fingers.

DO NOT attempt to unscrew this by twisting the On/Off Switch Assembly or Vacuum Hose. Unscrew ONLY the Knurled Locking Nut. Twisting the On/Off Switch Assembly or Vacuum Hose will damage the three power pins.

MAKE SURE THAT THE VACUUM HOSE ASSEMBLY DOES NOT TURN!

ONLY THE LOCKING NUT SHOULD TURN.

Step 5

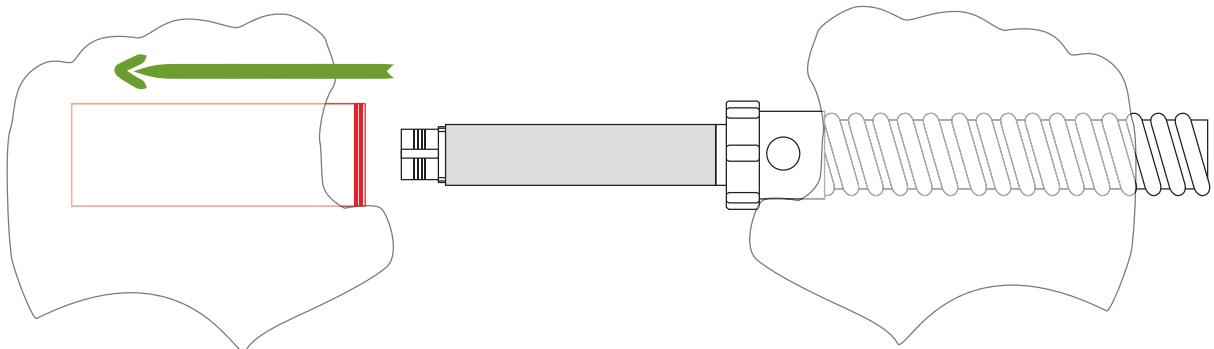

Once the Main Alloy Body has been unscrewed, slide it away from the Knurled Locking Nut and the Micro-motor will be exposed.

Step 6

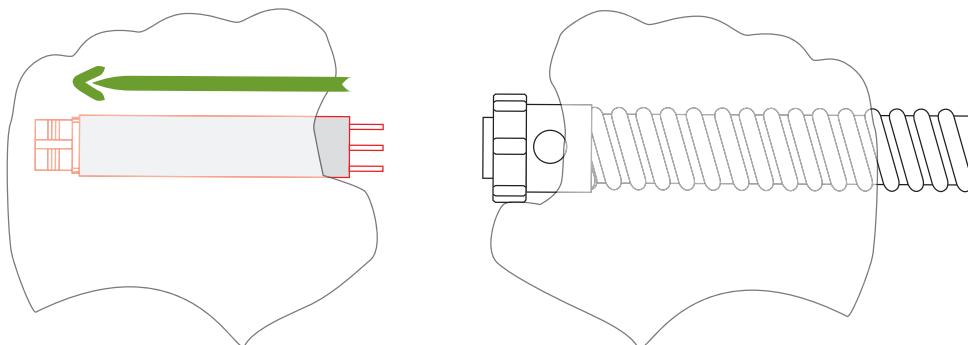

If you wish to now disconnect the Micro-motor from the Vacuum Hose On/Off Switch Assembly, then do so by holding the Vacuum Hose and gently pulling the Micro-motor from it.

DO NOT turn or twist the Micro-motor, On/Off Switch Assembly or Vacuum Hose when doing this.

Step 6

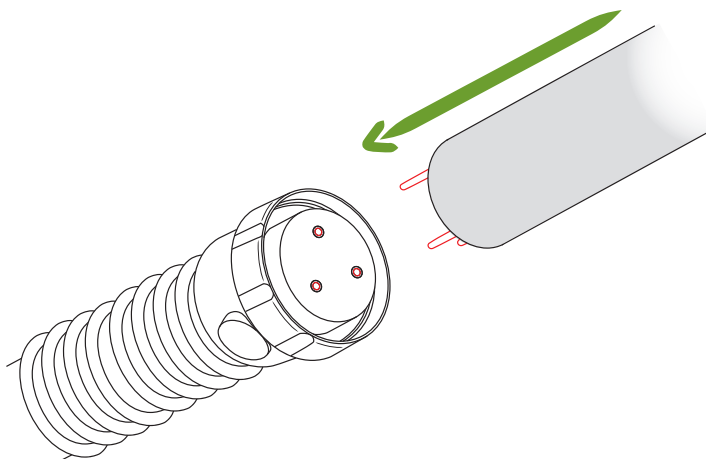

To re-assemble the Handpiece, carefully align the three "male" pins on the Micro-motor to the three receiving "female" pins in the On/Off Switch Assembly and push the motor all the way on.

Step 7

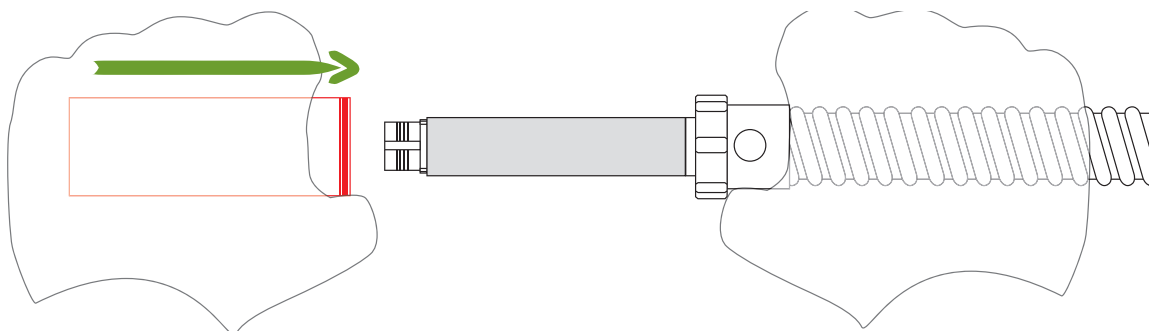

Slide the Main Alloy Body over the Micro-motor.

Step 8

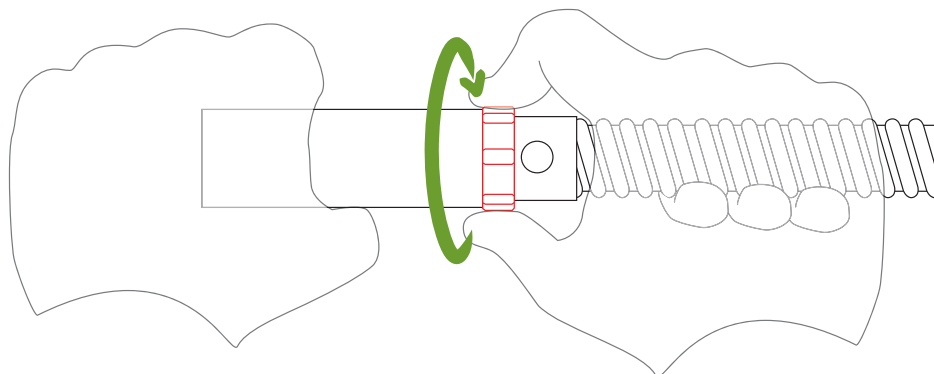

Screw the Main alloy body on by turning only the Knurled Locking Nut with your fingers.

DO NOT twist or rotate the Vacuum Hose or On/Off Switch Assembly while doing this as ANY rotational pressure placed on the three power pins may result in them being damaged, bent, or broken which will negate your warranty and you will incur the cost of a replacement micro-motor.

Step 9

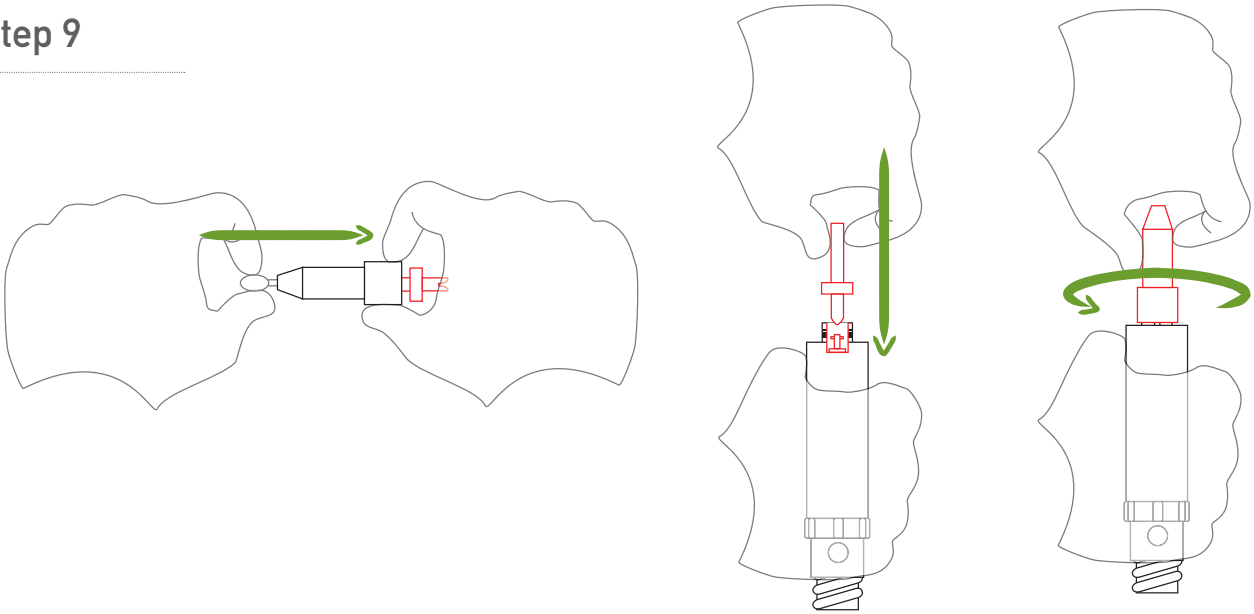

Before screwing the Burr Clutch Housing onto the Micro-motor, use a burr or mandrel to push the Burr Clutch Assembly from its housing. Now hold the Handpiece vertically and place the Burr Clutch Assembly into the Micro-motor ensuring the nylon slotted drive coupling nestles comfortably onto the "T" bar drive on the motor. Then screw the Burr Clutch Housing onto the Micro-motor.

Step 10

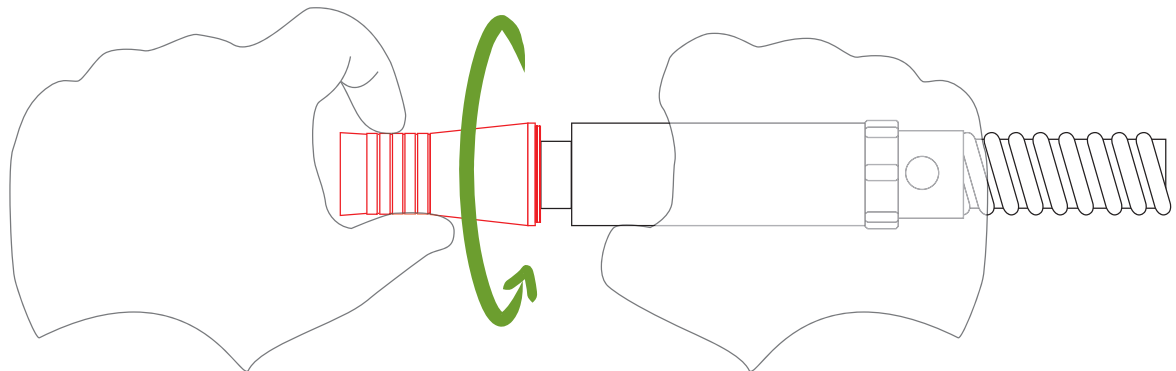

Then screw the Alloy Nose Cone onto the Main Alloy Body.

Step 11

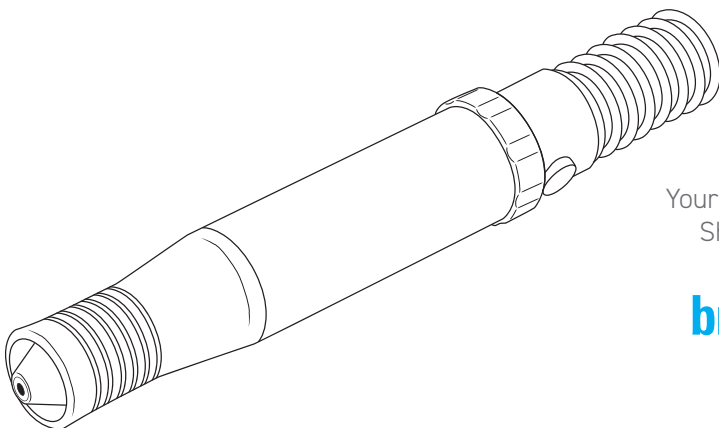

Your Handpiece is now complete and ready to use.
Should you have any problems or questions,
do not hesitate to contact

brigatemedicalcompany

on
Melb. Metro 8586 7800
Toll Free 1800 33 4142

Burr Clutch Service

A unique feature of the Berchtold handpiece is its ability to be completely dismantled, cleaned, and re-built. To ensure optimal performance of your Berchtold handpieces we suggest that this be performed every 2-3 weeks.

Step 1

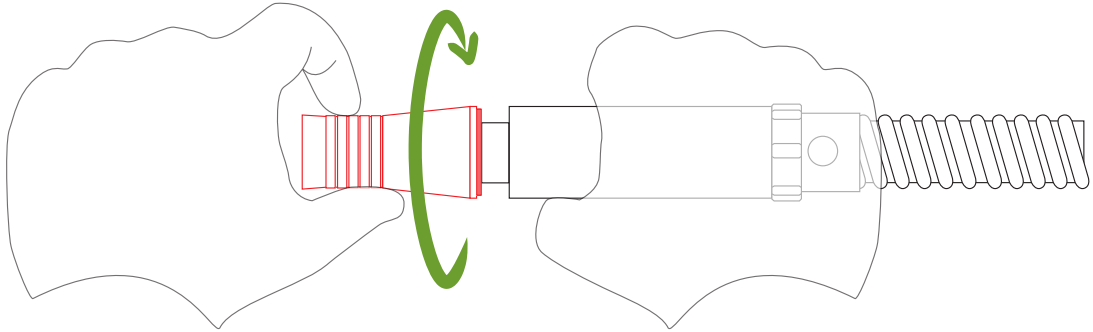

Remove any burr or mandrel that may be in the Handpiece. Hold the Main Alloy Body of the Handpiece in one hand, then unscrew and remove the Alloy Nose Cone. Wipe away any nail dust from the nose cone with a damp (not soaking wet) paper towel. An alcohol/chlorhexidine moistened towel is recommended.

Step 2

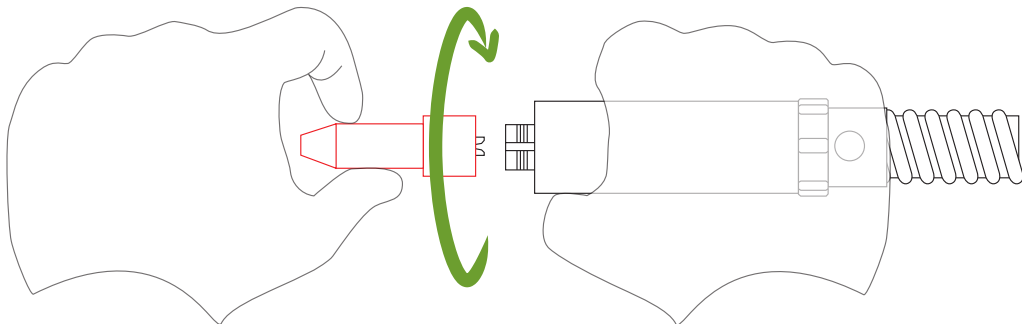

Whilst still holding the Main Alloy Body of the Handpiece, unscrew the Burr Clutch Housing. Put the Handpiece down and pick-up the Burr Clutch Housing.

Step 3

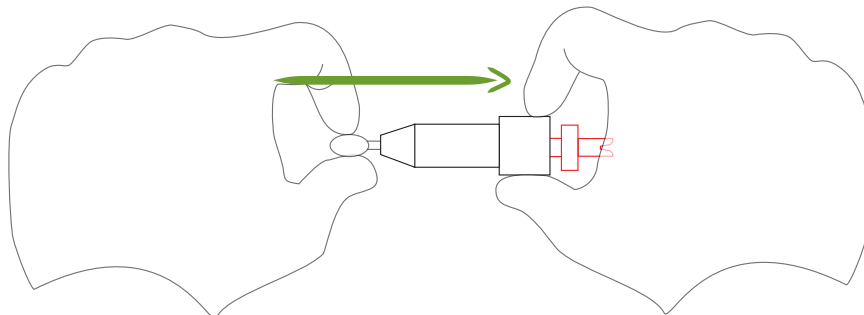

Using the shaft of a burr or mandrel, push into the Burr Clutch Housing and push the Burr Clutch Assembly out of the housing. Clean the empty housing in the same way as the nose cone.

Step 4

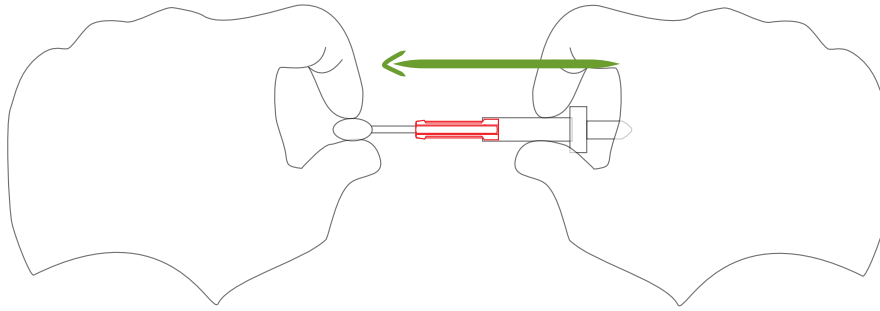

Put the shaft of the burr or mandrel into the Burr Clutch Assembly and draw the Clutch Fingers and the three Roller Bearings out of the Burr Clutch Assembly.

Ensure to do this step over a benchtop or flat surface as the three Roller Bearings in the Burr Clutch Assembly will fall out upon removal.

Step 5

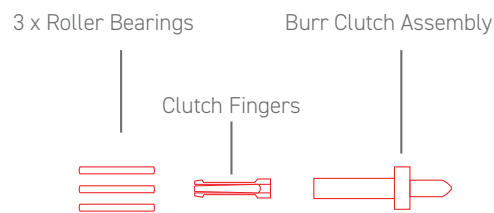

To clean these components use a clean paper towel to remove any nail dust from the Clutch Fingers, Roller Bearings, and the exterior of the Burr Clutch Assembly. Use a cotton tipped applicator to clean the interior of the Burr Clutch Assembly.

DO NOT APPLY ANY OIL OR GREASE.

Step 6

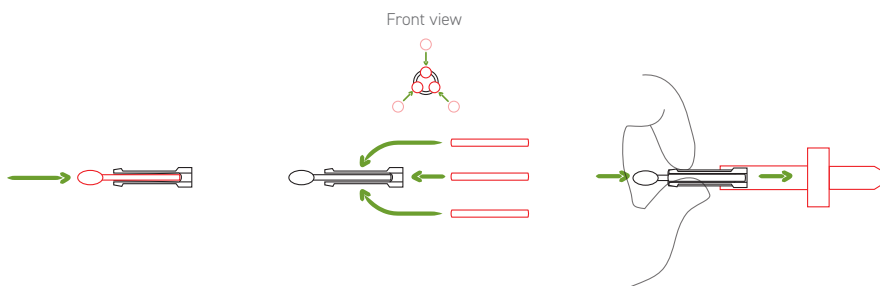

To re-assemble, put the shaft of the burr into the three pronged Clutch Fingers. Place the three Roller Bearings around the exterior of the Clutch Fingers (they will settle into place) then, while holding the Roller Bearings onto the Clutch Fingers, slide the assembled clutch back into the Burr Clutch Assembly.

Hold the fingers and rollers in the assembly and slowly draw the burr out.

Step 7

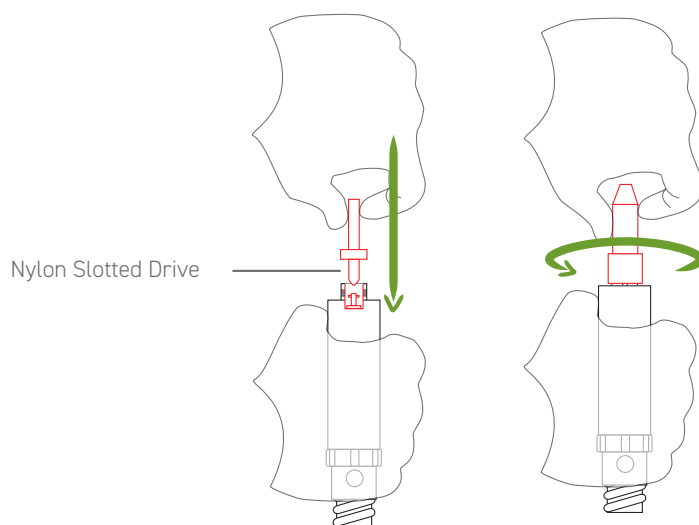

Pick up the handpiece and hold it vertically with the power lead down and the top of the Micro-motor up.
Place the Burr Clutch Assembly (without the housing on it yet) on the top of the Handpiece and ensure the Nylon Slotted Drive coupling nestles comfortably onto the "T" bar drive on the motor.

Now, lower the burr clutch housing over the burr clutch assembly and screw it firmly (not tightly) into place over the Burr Clutch Assembly.

Step 8

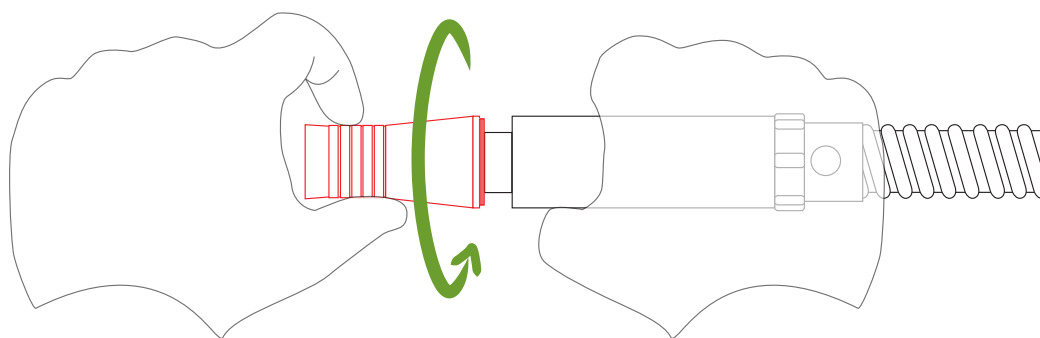

Screw the Alloy Nose Cone back onto the Main Alloy Body.

IMPORTANT NOTE:

Whenever you are screwing or unscrewing any part of the handpiece **ALWAYS** ensure you are only holding metal sections in your hands.

This will ensure that you do not put any "twisting" pressure on the three power connecting pins on the micro-motor.

S35-TS/PodoQ Handpiece Dismantling Video

Due to the unique style of the Handpiece on the S35-TS/PodoQ, it is extremely important that the procedures listed in this document are followed. Failure to do so could damage the Handpiece's micro-motor which will not be covered under warranty.

In conjunction with this manual, we have produced a video that outlines this process to further demonstrate it's importance.

Head to the the "Product Videos" section at www.briggatemedical.com (located at the top left of our home page) and scroll down to the video titled "Berchtold S35-TS Podiatry Drill Demonstration".

It is advised that any staff member who uses this drill is well aware of how to self-service the Handpiece and should view this manual and/or the video online.

The screenshot shows the Briggate Medical Company website. The top navigation bar includes links for "Product Videos | Research & Education | Service Dept | Instrument Care | Nail Surgery", which are circled in orange. Below the navigation bar is a search bar and a list of product categories. The main content area features a promotional banner for "walker's PediCreme [footcare treatment]". The banner includes a list of key active ingredients:

- Glycerin:** Helps with skin hydration and elasticity.
- Cyclomethicone:** Silicone based skin emollient which, unlike dimethylsiloxane rubs in easily and leaves a tack-free feel to the skin.
- Urea (5%):** Rehydrating.
- Lactamide MEA (ethanolamide of Lactic Acid):** Rehydrates the skin structure and stimulates cell renewal and cell turnover. Helps to prevent the thickening of the stratum corneum by inducing exfoliation.
- Dimethiconol:** Silicone based skin conditioning emollient.
- Pectone Chlorides:** Used for the treatment of fungal infections.
- Tocopheryl Nicotinate:** Improved and stimulated micro-circulation.

An inset video player is overlaid on the bottom right of the page. The video is titled "Berchtold S35-TS Podiatry Drill Demonstration" and is from Briggate Medical Company. The video player shows a play button, a progress bar, and a duration of 04:51. The video content shows a close-up of the Berchtold S35-TS podiatry drill handpiece.

Handpiece Holster Positioning

When attaching the Handpiece Holster to the side of your drill, please apply it below the lip of the ventilation plate located on the top right-hand corner of Main Control Unit.

This will greatly help our technicians when drill's are returned for routine servicing.

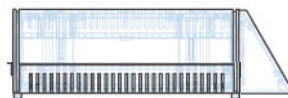
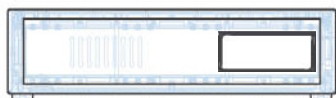
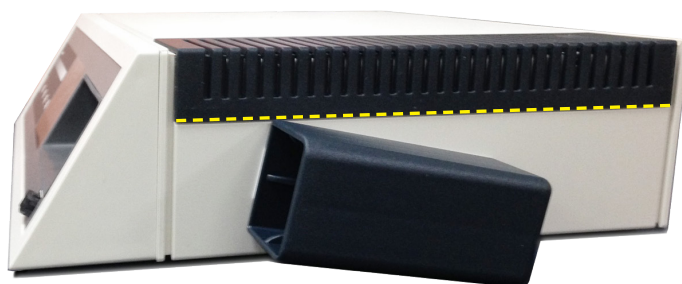

BERCHTOLD.
podoQ 40

Manufactured in Germany by:

BERCHTOLD GMBH & CO.KG
Freihofstraße 4
D-73730 Esslingen
Germany

Quality Drill Consumables

Refer to www.briggatemedical.com for our full range of drill consumables available from the following manufacturers:

Burrs:



Sanding Discs:

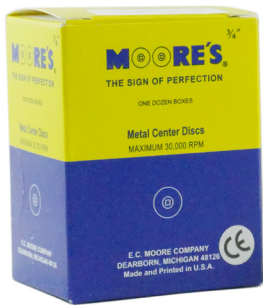

Mandrels:



Drill Carry Cases

Upright Domiciliary Case on Wheels

- Suitable for all Podiatry Drills available from Briggate Medical
- Extendable Handle and wheels for ease of movement
- Flip-down front to easily access Drill Tray
- Contains multiple drawers for storage of equipment

- Width: 400mm
- Depth: 300mm
- Height: 500mm

CASE-MOBIL

Large Upright Podiatry Domiciliary Case
on Wheels

Contact Briggate Medical for pricing



Hard Carry Case for Podiatry Drills

- Suitable for all Podiatry Drills available from Briggate Medical
- Soft foam inner for protection in transit

- Width: 515mm
- Depth: 420mm
- Height: 200mm

CASE-DRILZ

Hard Carry Case for Podiatry Drills

Contact Briggate Medical for pricing



BERCHTOLD.

briggatemedicalcompany

23-25 Lakewood Blvd
Braeside Vic 3195
Australia

Ph: (03) 8586 7800
Fax: (03) 8586 7888

briggate@briggate.com.au
www.briggatemedical.com